

# ADAM Industrial Data Acquisition Success Story Collection

Vertrieb durch



**AMC – Analytik & Messtechnik GmbH Chemnitz**

Heinrich-Lorenz-Str. 55    Tel.: +49/371/38388-0  
09120 Chemnitz    Fax: +49/371/38388-99  
E-Mail: info@amc-systeme.de    Web: www.amc-systeme.de

- ✓ Factory Automation
- ✓ Environmental Monitoring
- ✓ Urban Infrastructure
- ✓ Agriculture
- ✓ Oil and Gas
- ✓ Power and Energy



**ADVANTECH**

*Enabling an Intelligent Planet*



**ADVANTECH** iAutomation  
Premier Partner

# About ADAM

Advantech's ADAM series of remote I/O modules have been a consistent and reliable figure in the industrial automation field for over 25 years. Whether dealing with large or small systems, ADAM modules can always be found embedded somewhere as an integral keystone. They can be used in a great variety of applications across different industries. From factory and infrastructure to environmental applications, ADAM modules offer support with reliable functions and diverse features. Here, in this collection of application stories, we would like to take a moment to share some of the successes that these small devices have had in big applications.



## Factory Automation

Factory Automation Solution for Existing Machines	01
Precise Data traceability Reduces Time and Cost	03
Monitoring Real-time Operation Status for Quality Assurance	05



## Environmental Monitoring

### *Water Industry & Smart Water*

Data Collection and Analysis for Water Management	07
Real-time Monitoring Improves Water Project Safety	09
River Flow Monitoring to Reduce Damaged Impact	11

### *Air Emissions*

Environmental Protection Supportive for Seamless Data Transmission	13
CEMS Solution Meets National Environmental Requirements	15



## Agriculture

Monitoring the Modern Agricultural Demonstration Zone in Real-time	21
Remote Monitoring and Control on Web-based Devices	23



## Oil and Gas

On-site Data Collection in Harsh Offshore Environment	25
---	----

# About Advantech



Founded in 1983, Advantech is a leader in providing trusted innovative embedded and automation products and solutions. The company offers comprehensive system integration, hardware, software, customer-centric design services, and global logistics support, all backed by industry-leading front and back office e-business solutions. We cooperate closely with our partners to help provide complete solutions for a wide variety of applications across a diverse range of industries. Advantech has always been an innovator in the development and manufacturing of high-quality, high-performance computing platforms, and our mission is to drive innovation by offering trustworthy automation products and services. With Advantech, there is no limit to the applications and innovations our products make possible.



## Urban Infrastructure

Lighting Monitoring Improves Energy Conservation and Efficiency 17

Parking Facility Kiosk 19



## Power and Energy

### Power

Stable and Reliable Equipment Operation Improves Overall Safety 27

### Solar

Remote Automatic Data Transmission Achieves Efficient Human-Computer Interaction 29

### Wind

Real-time Monitoring Solution Simplifies the Field Operation 31



INDUSTRY Factory Automation

LOCATION China

Increasingly more enterprises need to transform and upgrade their production lines to intelligent manufacturing. The biggest problem for enterprise equipment monitoring is how to complete signal acquisition and establish communication between devices from different brands and of different types. This customer required the status of each of their machines to be monitored, including power on/off times, production quantities, and stack lights. Without the additional cost of purchasing new machines, Advantech offers an integrated solution that achieves factory automation with existing machines.

## Factory Automation Solution for Existing Machine Equipments

### System Requirements

This customer mainly produces precision molds, mold standard parts, and related injection products. Their production line has a total of 19 machine tools from three different brands, and several of these machines have been in service for more than 20 years. The following issues required consideration:

- Machines made by different brand manufacturers use different communication protocols, thus necessitating protocol conversion;
- Some old machines do not support communication interfaces, meaning that external sensors must be used;
- The workshop has many metal items that can cause signal interference, and its cramped space is inconvenient for wiring; therefore, the new system must have simple and convenient wiring.

The new system was required to monitor the status of different brands and generations of machine tools while also generating daily production reports, intuitively displaying the utilization of production line equipment, and providing information for shift handover.

### Project Implementation



**ADAM-6250**  
15-ch Isolated Digital I/O  
Modbus TCP Module



**EKI-2525**  
5-port Unmanaged  
Industrial Ethernet Switch



**UNO-2184G**  
Intel@ Core™ i7 Automation  
Computer with 4 x GbE, 2 x  
Mini PCIe, DVI/DP/HDMI

## System Description

The customer wanted to monitor the machines' operating status. However, most old machines do not have communication ports, and for those that do, it is difficult to obtain the communication protocols from suppliers. Therefore, various sensors were installed in the machines for signal acquisition, with the ADAM-6250 utilized to obtain the status of the machines (e.g., running, shut down, idle, breakdown) and stack lights.

- ADAM-6250 modules were installed on each machine. A daisy chain configuration was adopted to connect neighboring modules in order to minimize on-site wiring. Collected data were then aggregated on a local UNO-2184G automation computer.
- Because the workshop was far from the control center, an EKI-2525 switch was adopted to forward the data to the control room.
- Advantech's professional service integrators were able to refit machines so that signal data could be collected via sensors. The machines' operating status can then be collated into reports in order to view the efficiency of on-site equipment.

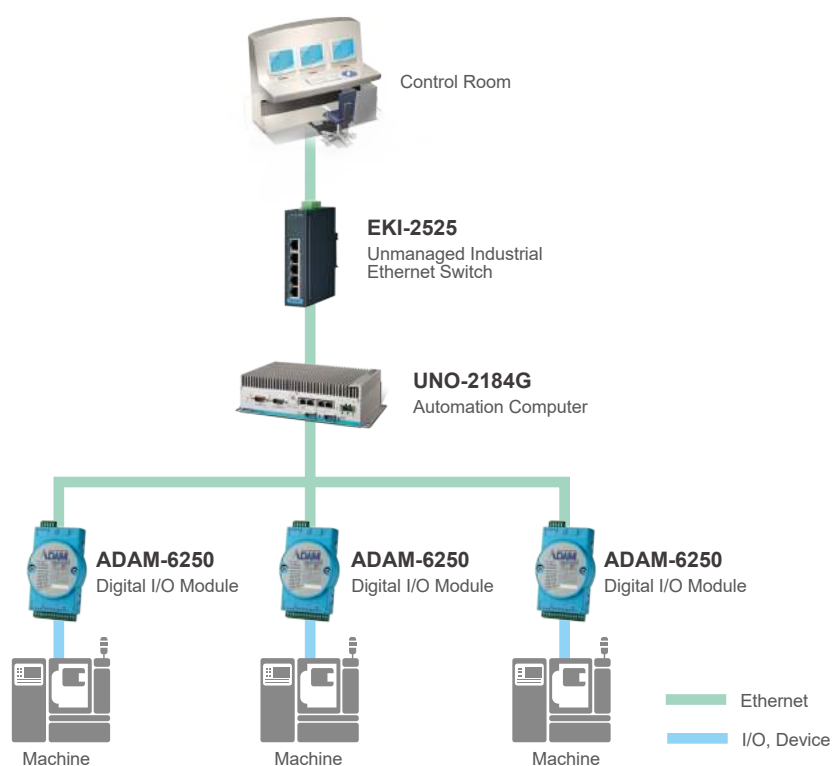

## Conclusion

Advantech can provide rugged, stable, and cost-effective total solutions that include remote I/O modules, switches, and industrial-grade computers. For this customer, the system enhanced production efficiency by more than 30%. Furthermore, the system has an alarm mechanism and fault button so that the health of the equipment can be monitored; this has facilitated timely repair and maintenance planning, thus improving the equipment life span, reducing the number of equipment failures, and saving more than 20% on hardware costs.



INDUSTRY | Factory Automation

LOCATION | China

China's booming automobile market has increased demand for car safety. One system aimed at this end provides a total solution for detecting automotive water intrusion from rainfall. This customer required solution for their vehicle rainfall testing workshop, which did not have a procedure in place for setting the rainfall intensity. Given the importance of data traceability in the automotive industry, automakers have realized the necessity of using consistently measureable rainfall detection systems.

# Precise Data Traceability Reduces Time and Cost

## System Requirements

Rain collection units were connected to a TPC-1282T host computer with WebAccess software installed for configuration, wireless data aggregation, and solenoid valve control. The computer provided easy access to data such as rainfall intensity and solenoid valve status. The customer required high-hardness PC to perform simple processing while being waterproof, lightweight, robust, and yet attractive in appearance. At the project design stage, however, the customer encountered many problems, including product size, signal stability, on-site wiring, cost control, and the accuracy being influenced by environmental/external conditions.

## Project Implementation



**ADAM-6024**  
12-ch Isolated Universal  
Input/Output Modbus  
TCP Module



**EKI-6332GN**  
IEEE 802.11 b/g/n Wi-Fi  
AP/Client



**TPC-1282T**  
12.1" XGA TFT LED LCD  
Intel® 5th. Gen. Core™ i3  
Touch Panel Computer



**WebAccess**  
Browser-based HMI/SCADA  
Software

## System Description

Advantech proposed a cost-effective solution to address the customer's problems. The system included an ADAM-6024 universal I/O module, which integrates high-precision analog signal acquisition and digital control in a single unit. Because the rain collection unit had to be easy to move, the ADAM-6024's compact size made it the ideal for selection for capturing sensor data, which were then uploaded to the TPC-1282T via an EKI-6332GN wireless AP/client, which is also rated IP55 (dustproof and waterproof) and offers stable wireless transmission.

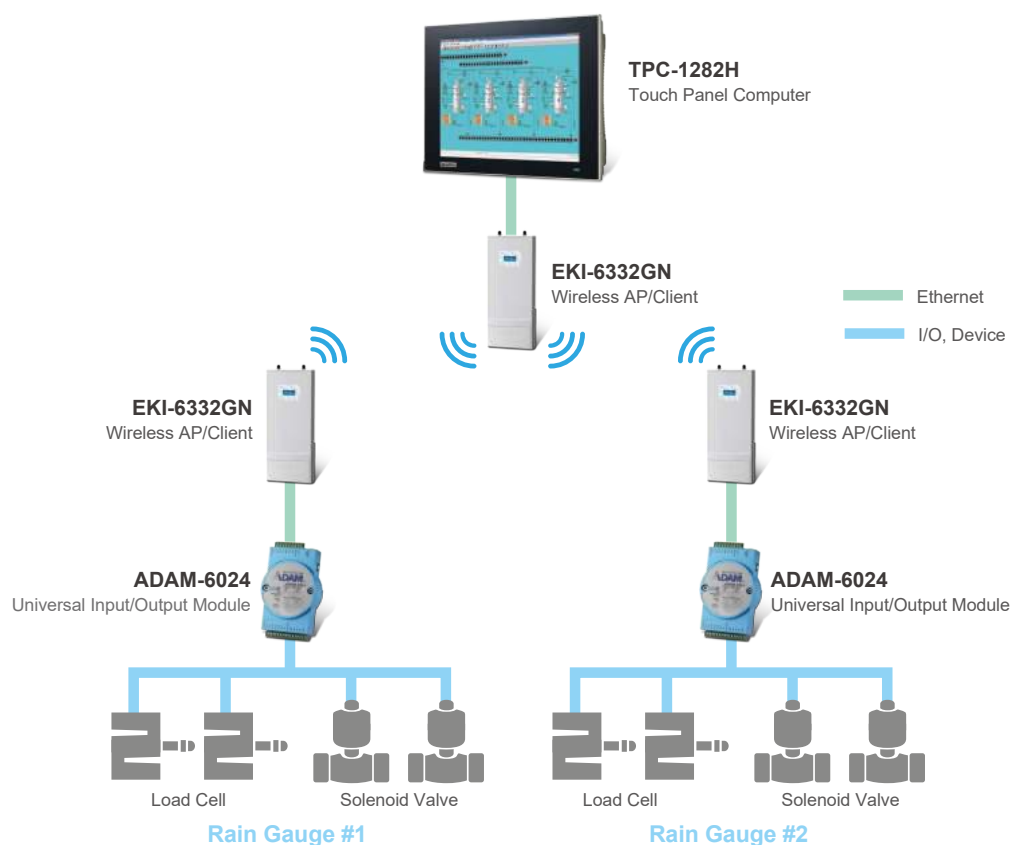

### Conclusion

Modern systems are becoming increasingly more miniaturized. Advantech ADAM I/O modules are in line with this trend with their compact size, efficient operation, and low power consumption, all of which are advantageous for customers. Furthermore, Advantech offers a one-stop shopping service for its hardware and software solutions, from data acquisition and transmission to storage and analysis. Advantech's ability to provide complete solutions saves customers time and money.



INDUSTRY Factory Automation

LOCATION China

The informatization of automaker factories is driving parts manufacturers to upgrade the extent to which they digitalize their own factories. Parts manufacturers are required to enhance their design capacity and degree of digitalization in order to provide effective quality assurance measures. When parts manufacturers seek to improve their management and production efficiency, production must be reformed with a focus on IT integration and managerial transparency, so as to create an intelligent factory with effective equipment automation and information management systems.

## Monitoring Real-Time Operation Status for Quality Assurance

### System Requirements

The production workshop of an automobile parts manufacturer with a typical layout for automobile parts production, including equipment for melting, casting, mechanical processing, surface treatment, and other key processes, had equipment that had been supplied by various suppliers, resulting in different machines having different technical standards and control systems. In the process of factory informatization, it had become difficult to connect all of the devices and collect data due to the complexity of device data unification.

To conduct quality management, traceability analysis, material loss calculation, allocation tracking, and inventory management, this customer required

real-time information on the operating status of equipment in each process, including the product model, number of machines, manufacturing processing information, and WIP status. The customer also required a system that could provide several key functions: production scheduling for work order management; customer order-tracking to ensure timely shipments; real-time alarm notifications for production exceptions; equipment maintenance/management for automatic reminders for maintenance; production indicator analysis to maximize equipment efficiency; automatic data acquisition for instant, accurate, objective information; automatic report generation to realize a paperless factory; and employee productivity-tracking to provide an objective basis for assessment.

### Project Implementation



**ADAM-6017**  
8-ch Isolated Analog Input Modbus TCP Module with 2-ch DO



**ADAM-6250**  
15-ch Isolated Digital I/O Modbus TCP Module



**UNO-2473G**  
Intel® Atom/ Celeron Processor Regular-Size Automation Computer with 4 x GbE, 3 x mPCIe, HDMI/VGA



**WebAccess**  
Browser-based HMI/SCADA Software



## System Description

The whole system comprised four levels: low-level equipment collection layer, workshop information layer, network layer, and the management layer (information center). These are described as follows:

- Equipment collection layer: ADAM-6000 series Ethernet I/O modules were used to acquire production equipment data (e.g., melting furnace temperature, CNC machining tool processing data, and equipment status) throughout the entire manufacturing process.
- Workshop information layer: A UNO-2473G embedded with WebAccess/MDC/DNC/third-party driver interface software was adopted for collection applications. With this, the workshop information station acts as a data gateway for collecting and temporarily storing NC data.
- Network layer: This layer provides a communication link for transmitting workshop information data from the workshop to the information center.
- Management layer: At this layer, all data are aggregated for analysis and decision-making.

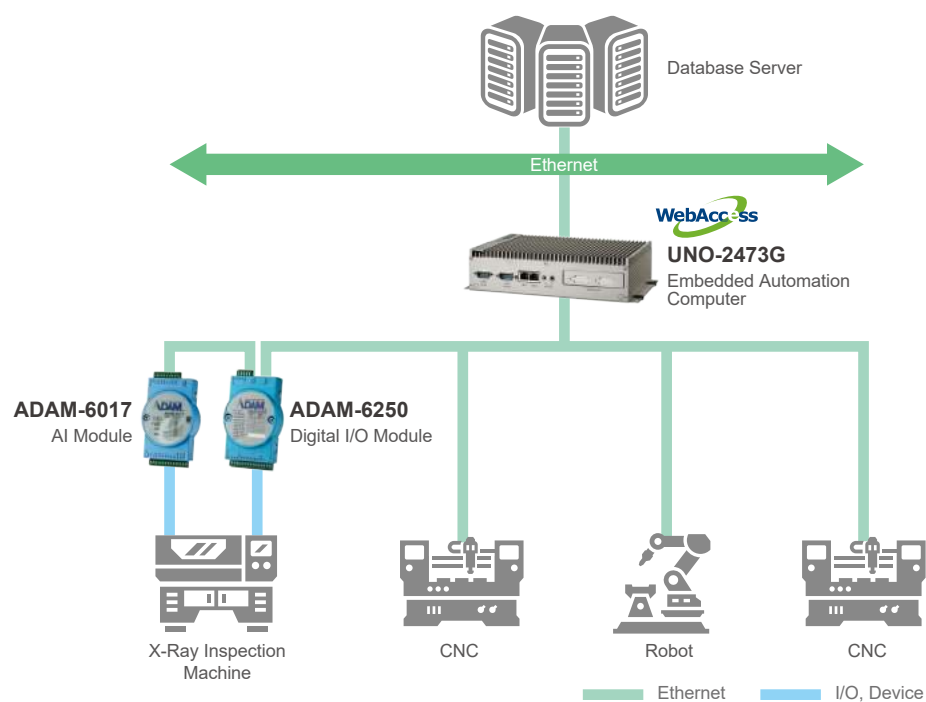

## Conclusion

The proposed system provided a total solution, from equipment monitoring/data collection to gateway integration and installation/monitoring of network communication devices.

This system included ADAM-6017 and ADAM-6025 modules, which were adopted to unify the management of devices and directly collect I/O data, and the UNO-2473G, which was utilized to integrate data and communicate with the management system. The system can also aggregate CNC data and robot information, thus providing an effective platform for factory informatization.



INDUSTRY Water Industry & Smart Water

LOCATION China

Natural disasters are relatively frequent in China. Developments in real-time hydrological data collection have had a significant impact on improving hydrological alarm systems and flash flood warning systems. Collected data have also provided a scientific basis for improving management systems for flood prevention, hydropower dispatching, and water resource development/utilization. Thus, accelerating the development of hydrological forecasting systems with data analysis is a major task in China's national socioeconomic development planning outline.

# Data Collection and Analysis for Smart Water Management

## System Requirements

This customer needs to utilize data on several water environments to develop a forecasting system for rainfall/river conditions in order to assist with decision-making pertaining to flood control.

The system was required to record real-time data on rainfall and river conditions in river basins for real-time dynamic flood forecasting, dispatching reservoir water resources in a reasonable manner, improving water resource utilization, balancing water supply and demand, and minimizing losses from floods. The design also had to facilitate managing the water environment, preventing

water pollution, minimizing losses from water pollution disasters, and ensuring water resource sustainability.

A further requirement was that it had to enhance the non-engineering effect by issuing an early warning for staff to implement appropriate measures. For this, it needed a geographic information system (GIS) for data visualization to decision-making, and it had to allow users to query specific information to derive scientific basis for measures aimed at flood, drought, and pollution prevention, as well as emergency rescue and disaster relief operations.

## Project Implementation



**ADAM-4117**  
Robust 8-ch Analog Input  
Module with Modbus



**EKI-7659CI**  
8+2G Combo Port Gigabit  
Managed Redundant Industrial  
Ethernet Switch with Wide  
Temp



**UNO-2473G**  
Intel® Atom/ Celeron Processor  
Regular-Size Automation  
Computer with 4 x GbE, 3 x  
mPCIe, HDMI/VGA

## System Description

To acquire accurate data in real time, the system required four key components: a central information monitoring platform, a fiber optic Ethernet communication network, a front-end monitoring terminal with a data acquisition module, and on-site sensing devices.

- Central information monitoring platform: A combination of monitoring computers and data servers for decoding, storing, displaying, and processing remotely acquired data
- Communication network: Fiber optic Ethernet communication to ensure reliable network redundancy
- Front-end monitoring terminal with remote I/O modules: ADAM-4100 modules to collect data from sensing devices for transmission to the information monitoring center via a wired network
- On-site sensing devices: Including rainfall sensors, water level meters, and other meter transmitters

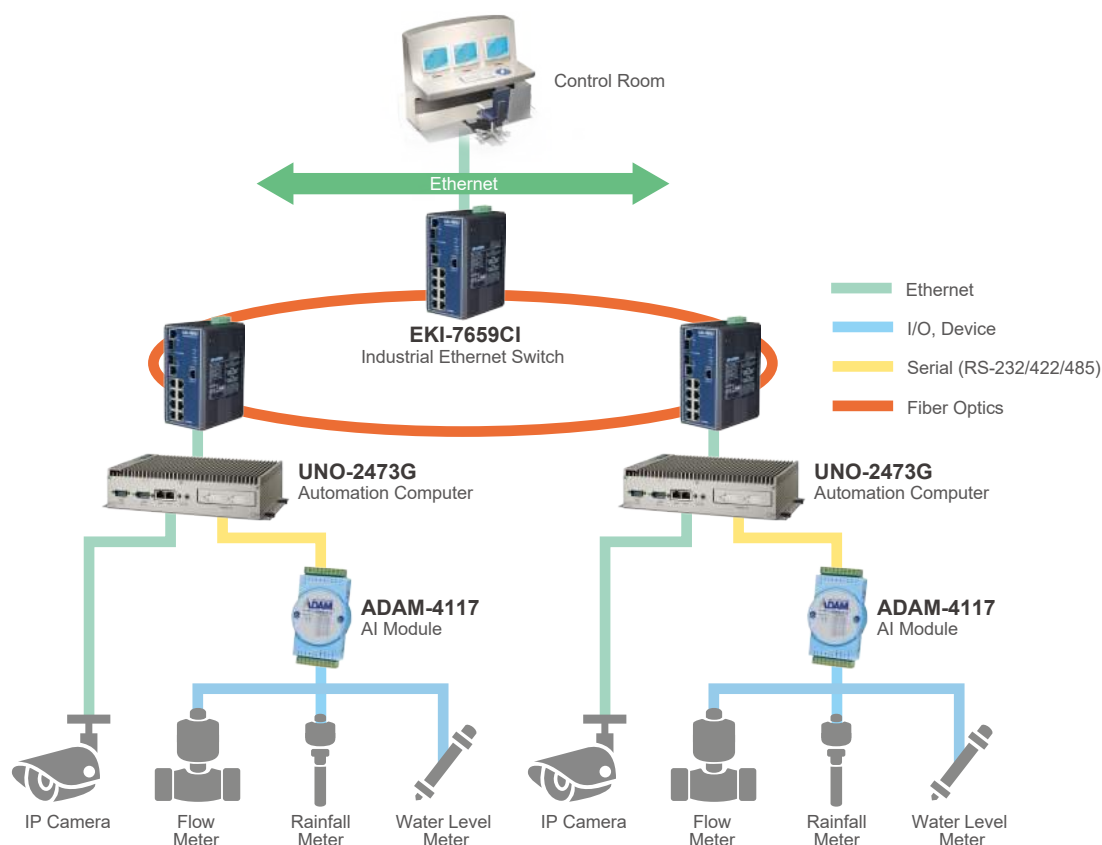

## Conclusion

Advantech's industrial-grade product offerings played a key role in the project. The solution was selected because the system must be able to operate in harsh environments, with on-site temperatures ranging from -10°C in winter to more than 40°C in summer. To ensure stable system operation, the customer adopted an Advantech embedded fanless computer, ADAM-4117 remote I/O module, and EKI-7659CI industrial-grade communication devices, which support wide operating temperatures, thus ensuring high reliability in outdoor applications.



INDUSTRY Water Industry & Smart Water

LOCATION China

The Chinese Government initiated the South-to-North Water Diversion Project (SNWDP) to upgrade water infrastructure in Northern China. The security system installed along the central diversion route, which extends from Henan in the south to Beijing in the north, includes a video surveillance system, an intelligent electronic fence system, a comprehensive monitoring and information service system, and other support systems.

# Real-Time Monitoring Improves Water Project Safety

## System Requirements

The overall security system was designed to monitor the entire area with a particular focus on critical facilities. The video surveillance system was connected with the electronic fence system and other systems to realize intelligent video security management for the central diversion route. The video surveillance system also needed to enhance the three safety preventive measures for this project—namely engineering safety, water supply safety, and personnel safety—while improving both project security and management standards.

The video system mainly comprised cameras, audio capture devices, optical switches, and other communication devices, all of which had to be of industrial grade to be suitable for the on-site environment. In addition, various supporting devices and equipment were required, including power cables, solar power equipment, camera poles, mounting accessories, fiber optic splitters, and lightning/surge protection devices.

## Project Implementation



### ADAM-6052

16-ch Source-type Isolated Digital I/O Modbus TCP Module



### EKI-7629C

8+2G Combo Port Gigabit Unmanaged Industrial Ethernet Switch

## System Description

The security system for the central diversion route focuses generally on improving engineering safety. Through the utilization of IoT, digital video, communication, computers, networks, and various technologies to create a three-dimensional structure, the intelligent security system can be integrated with an automated scheduling management system to ensure that technical devices, material resources, and staff are dispatched as required.

### Video monitoring and sound alarm system

The front-end control box, which has a built-in fiber switch, enables the video monitoring system to connect to the security system's fiber optic network via the fiber optic splitter, which adopts 6-core single-mode fiber optic cable. The control box uses fiber jumper wire to connect to the fiber optic splitter. The video monitoring system and security system switch are located at a local communication station and are linked by optical fiber in a star topology.

An audible alarm device installed at the site automatically issues a warning in the event of an emergency. When the field alarm sounds, the monitoring software transmits an audible warning via the video server and the onsite ADAM-6052 I/O module issues an alert through outdoor horn speakers according to the corresponding logical relationship of the different zones. The ADAM-6052 plays a critical role by sending an alert so that immediate action can be taken to improve project safety.

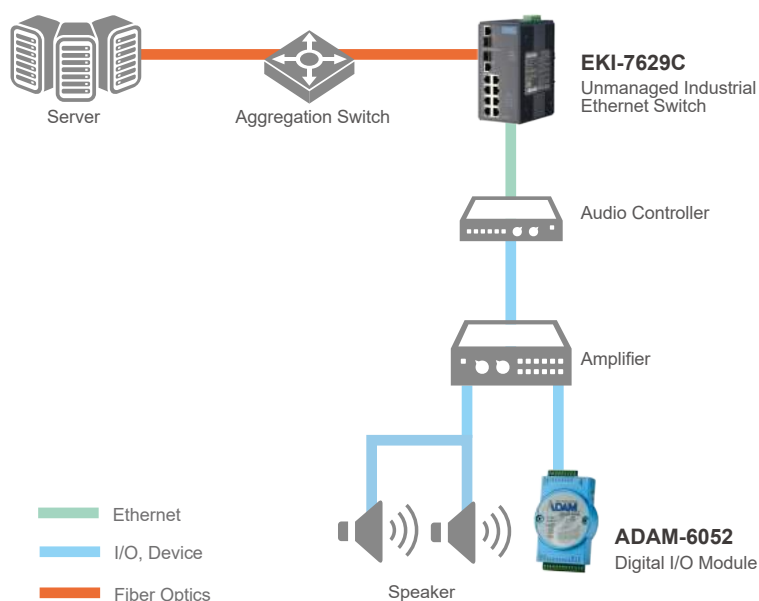

### Conclusion

Advantech is a well-known enterprise in China's industrial control industry and is also the first choice of supplier for its strict quality standards. The security system improved project safety, safety management standards, and efficiency, thus fully supporting the three safety preventative measures.



INDUSTRY Water Industry & Smart Water

LOCATION Spain

In mountainous regions around the world, heavy rainfall can cause downstream river flooding, resulting in major problems for residents and businesses in such areas. Many governments around the world have taken steps to actively protect people's livelihoods and property with the expansion of early warning systems and emergency response systems to reduce the impact of natural climate changes.

# River Flow Monitoring for Damage Mitigation

## System Requirements

In Spain, the government is trying to protect its citizens from rising river levels flowing down from the Pyrenees, with water level sensors installed along every kilometer of the rivers. The ability to track rainfall, water level, and flow rate data means that early flood warnings can be issued and that further action be taken when necessary. This customer required a system that had proven reliability and would be capable of withstanding harsh environmental conditions in remote locations. Thus, implementing a system that can function at high humidity and handle acute changes in temperature was priority. In addition, the system had to provide timely reporting on environmental conditions to ensure a quick response in order to minimize any potential damage.

## Project Implementation



**ADAM-5017**  
8-ch Analog Input Module



**ADAM-5051D**  
16-ch Digital Input Modules



**ADAM-5056D**  
16-ch Digital Output Modules



**ADAM-5560**  
7-slot PC-based Intel® Atom™ CPU soft logic Controller

## System Description

Advantech provided a total solution with advanced technology and robust equipment for monitoring sensors in remote locations. In addition to data monitoring, the whole system was able to function reliably in harsh environments.

From the sensors installed along the sides of the rivers, data are relayed to a cabinet in which are installed four ADAM modules, and these analyze the data before transmission to the central control room. The ADAM-5560 is a programmable automation controller that can be utilized to access sensor data and visualize the data on a monitor. These modules can also be used to analyze the data before sending them to a remote server.

With 16 digital input channels with LED indicators, the ADAM-5051D and ADAM-5056D were employed to monitor the sensors' working condition. The ADAM-5017 was also adopted for its ability to accept multiple voltage and current inputs, making it particularly useful for measuring the water height.

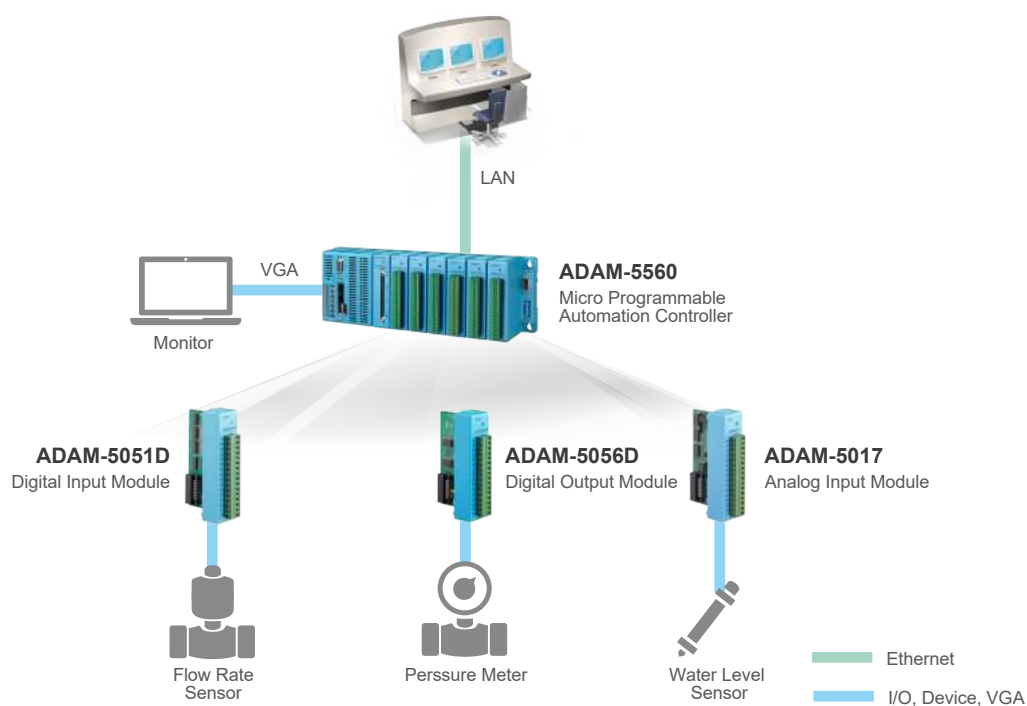

## Conclusion

The features of the ADAM-5560 were one of the key factors in winning this bid. Advantech offers this control system to ensure reliable operation in such harsh environments, thus providing the means to mitigate any potential impact from flood damage. Advantech's total solution not only fit the requirements but also won the customer's trust. Moreover, the customer has been using Advantech products in other projects and is familiar with the ADAM series' reliability.



INDUSTRY Air Emissions

LOCATION China

In recent years, China's Environmental Protection Agency (EPA) has implemented new national environmental protection standards and regulations that require companies to upload their environmental data to an EPA database. To meet the new standards, companies must make certain hardware changes; for instance, products that previously adopted the Arm architecture must be changed to X86 data platforms for on-site data processing and temporary data storage.

## Environmental Protection Support for Seamless Data Transmission

### System Requirements

With rising public awareness on energy conservation and emission reduction, the contribution of China's environmental protection industry to GDP is growing. Concurrently, the level of clean coal technology has improved substantially. Flue-gas desulfurization technology has been an international leader in this regard. Numerous major breakthroughs have been also made in ultralow emission coal-fired technology, and the utilization efficiency of clean coal processing has been improved considerably.

This customer had been using locally produced hardware and software to integrate environmental protection and management systems. However, the customer was dissatisfied with the service quality of the local producer and the performance of their products. Therefore, they sought a solution that can acquire data related to environmental protection, transmit the data via GPRS, and link to the local EPA through the special protocol.

### Project Implementation



**ADAM-4017+**  
8-ch Analog Input  
Module with Modbus



**BB-UR5I2F485USSWH**  
3G UMTS/HSPA router UR5i v2



**FPM-2150**  
15" XGA Industrial Monitor  
with Resistive Touchscreen  
and Direct-VGA Port



**UNO-2473G**  
Intel® Atom/ Celeron Processor  
Regular-Size Automation Computer  
w/ 4 x GbE, 3 x mPCIe, HDMI/VGA



**WebAccess**  
Browser-based HMI/  
SCADA Software



## System Description

For this project, each monitoring node had to collect various data, including flue gas temperature, pressure, humidity, moisture, and dust. In addition to needing to be uploaded to the EPA platform, the data also had to be visualized on a monitoring platform and used to generate a series of reports. To this end, Advantech's ADAM-4017+ remote I/O module was used to collect the field data, a BB-UR5IV2F485USSWH 3G UMTS/HSPA router was employed to upload the data to the EPA platform, and a UNO-2473G automation computer with embedded WebAccess software was adopted to interpret/analyze the data and generate the report. Because WebAccess supports the environmental protection 212/660 protocol, it is able to upload the data to the EPA platform.

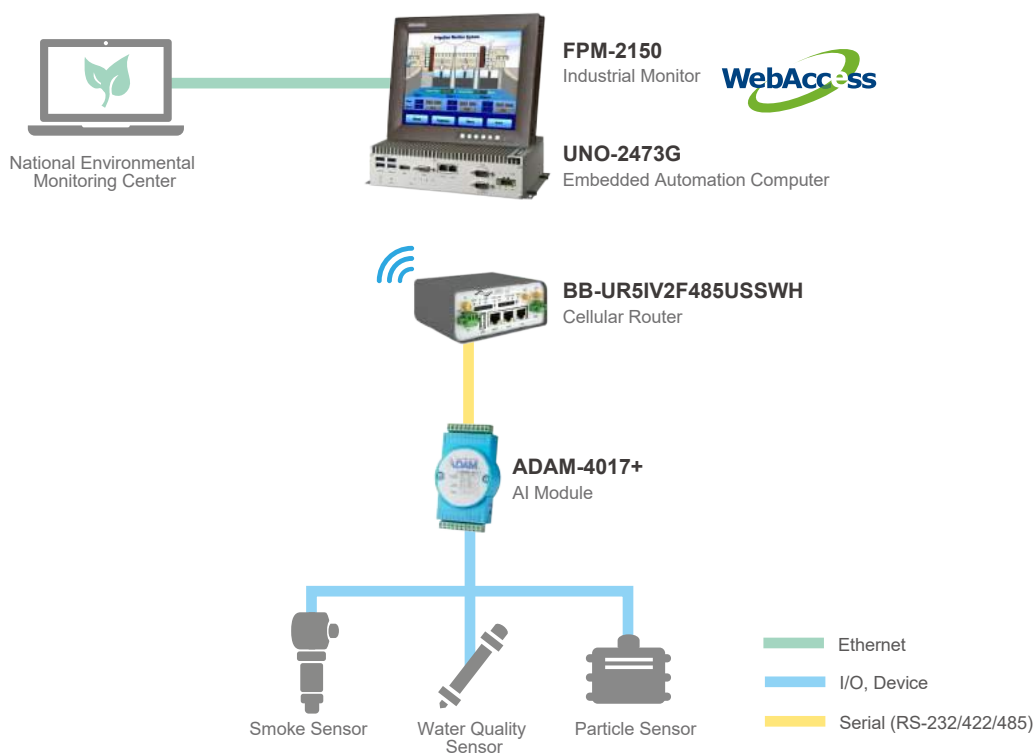

## Conclusion

Advantech offers a full range of products for data collection and transmission. The ADAM series of I/O modules is able to acquire environmental protection data to meet customer's requirement. Additionally, all of Advantech's products are of industrial-grade quality, from I/O data acquisition modules and data gateways to Ethernet communication modules, industrial PCs, and SCADA remote-monitoring software. Because the provided solution supports the dedicated EPA protocols (flue gas 212 and water quality 660), other local environmental protection enterprises can also use it to seamlessly link to the EPA platform and benefit from the efficiency and reliability of Advantech's total solution.



INDUSTRY Air Emissions

LOCATION China

As the Chinese government continues to improve the country's environmental management systems, its policy has shifted from establishing pollutant concentration limits to controlling the total amount of emissions. Accordingly, critical environmental quality indicators have also gradually changed to reflect this shift. In this transformation, the most urgent problem requiring a solution is to quickly establish an emission monitoring system as a means of management supervision. In particular, the system must meet requirements pertaining to controlling the total amount of emissions.

# CEMS Solution Meets National Environmental Requirements

## System Requirements

This project was mainly aimed at monitoring flue gas emissions at iron, steel, and chemical plants. In the past, the monitoring of pollutant emissions in China was focused on their concentrations. However, the monitoring frequency was very low, and the results seemed random given that they were based on estimates. Advantech's ADAM remote I/O modules and fanless host computers were thus ideal for independent data analysis and storage.

An automatic flue gas monitoring system was designed to target gas pollutants and particulate matter in the atmosphere by continuously monitoring their concentration and total emissions. The data were then to be transmitted to the relevant authority. This monitoring system comprised subsystems for monitoring gaseous pollutants, particulate matter, and flue gas parameters, as well as subsystems for data processing and transmission.

## Project Implementation



**ADAM-4055**  
16-ch Isolated Digital I/O  
Module with Modbus



**ADAM-4117**  
Robust 8-ch Analog Input  
Module with Modbus



**TPC-1251T**  
12.1" TFT LED LCD Intel®  
Atom™ Thin Client Terminal

## System Description

Given the significance of both data collection and transmission in this project, Advantech offered a total CEMS solution that would bring system performance into line with national environmental regulations. ADAM-4000 series modules were employed to acquire data from dust meters and other devices for measuring pollutant concentrations (including SO<sub>2</sub>, NO<sub>x</sub>, HCL, CO, CO<sub>2</sub>, etc.) and total emissions. The data can then be directly uploaded to a host computer for analysis. This enabled the customer to make a quick action to improve the overall air quality.

- **Data Acquisition:** ADAM-4117 and ADAM-4055 digital/analog I/O modules
- **Host PC:** Embedded fanless all-in-one computer

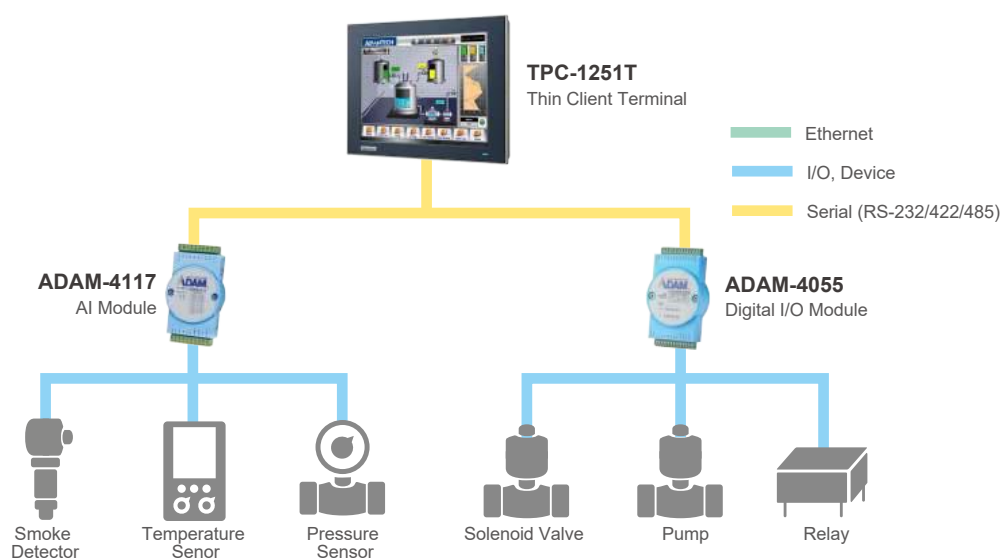

## Conclusion

Advantech can offer total hardware solutions that improve system automation, stability, and reliability. ADAM-4000 series modules are compact, versatile sensor-to-computer interface units designed specifically for reliable operation in harsh environments. Thus Advantech's brand awareness and high-quality services give customers peace of mind in using system. Furthermore, the provided solution not only reduced costs for this customer but also met national environment requirements.



INDUSTRY Urban Infrastructure

LOCATION China

Rapid urbanization in China has improved the social economy and people's living standards. Without exception, such developments bring greater demand for city street lighting, which, in addition to enhancing the image of the city and improving the urban environment, results in a substantial increase in energy consumption. Current developments in urbanization—particularly those for urban street lighting—focus strongly on energy conservation. To achieve efficiency, closely monitoring the lighting and the measurement system are necessary.

# Lighting Monitoring Improves Energy Conservation and Efficiency

## System Requirements

In China, Shenyang City's renovation project for energy-efficient road lighting adopted a contract energy management model. This green lighting project was aimed at replacing high energy-consumption lamps with LED lamps on selected roads and plazas. For this, a city street lighting monitoring and energy consumption measurement system was needed to detect and analyze changes in active power. This would allow for the status of lights in a given area to be detected and for relevant personnel to be alerted for on-site processing.

## Project Implementation



**ADAM-4024**  
4-ch Analog Output  
Module with Modbus



**ADAM-4055**  
16-ch Isolated Digital I/O  
Module with Modbus



**ADAM-4117**  
Robust 8-ch Analog Input  
Module with Modbus



**EKI-1361**  
1-port RS-232/422/485 to  
802.11b/g/n WLAN Serial  
Device Server



**WebAccess/EMS**  
**SRP-EEM351**  
Factory Energy  
Management Solution



**WebAccess**  
Browser-based HMI/  
SCADA Software

## System Description

Advantech's solution saves on energy costs and reduces maintenance by providing the hardware and software needed to establish an efficient energy management system (EMS). With data acquisition gateways that support multiple protocols and network connections, Advantech's WebAccess software, and high-performance industrial computers, the system can perform remote real-time monitoring and intelligent analysis to help managers identify abnormal energy consumption and areas requiring improvement.

To reduce energy consumption, street lights were fitted with ADAM-4024 remote I/O modules to control the lamp intensity according to current lighting conditions. Related data were collected using ADAM-4117 and ADAM-4055 remote I/O modules and uploaded to a monitoring center via a wireless LAN serial device server. WebAccess was customized specifically for this urban street lighting project in order to facilitate measuring, visualizing, and analyzing the overall amount of energy consumed.

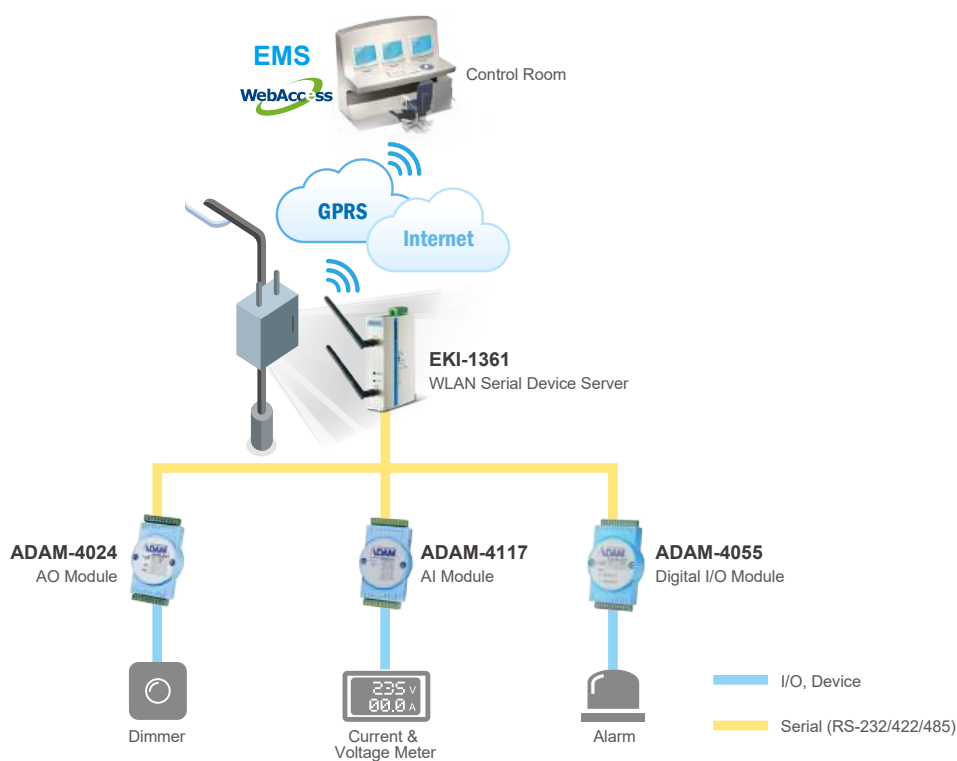

## Conclusion

Advantech's city street lighting monitoring and energy consumption measurement system has been applied to selected roads and plazas in Shenyang City. The ADAM modules in particular have been instrumental for collecting current and voltage data to determine the status of lights and for controlling illumination sensors for the lamp intensity. These modules allow the EMS solution to provide real-time information to inform management of the current status of street lighting infrastructure.



INDUSTRY Urban Infrastructure

LOCATION Taiwan

In parking facility equipment implementation, other than the infrastructure of gate control, facility monitoring, and safety alarm monitoring, parking facility kiosks are critical equipment that require a rugged and weather-resistant design to fulfil their roll in industrial automation. An obvious benefit of these kiosks is that they can reduce the need for multiple attendants and security guards by automating tasks such as collecting payment and lifting the gate, or even more complex needs such as storing credit card information.

## Parking Facility Kiosk

### System Requirements

For automated payment systems, Advantech has developed a concept that utilizes an industrial computer as the user interface. The computer is ideal due to its wide operating temperature range and ability to handle XP Embedded (or later) for easy application development. The computer also has several USB ports for connecting to such devices as RFID readers, swipe card readers, bill

validators, and thermal printers.

For different varieties of relay and digital I/O control, the computer can be expanded to include compact I/O cards such as the PC/104 or PCI-104. To accommodate installation in outdoor and semi-outdoor environments, Advantech recommends a 1200-nit high-brightness display.

### Project Implementation



**ADAM-6060**  
6-ch Digital Input and 6-ch Relay Modbus TCP Module



**FPM-7151T**  
15" XGA Industrial Monitor with Resistive Touchscreen, Direct-VGA/DP and Wide Operating Temperature Range



**UNO-2178A**  
Intel® Atom™ D510 Automation Computers with 6 x USB, 8 x COM, 2 x Mini PCIe

## System Description

This customer was seeking an automated payment system as a total solution from data acquisition to management. The customer requested a touchscreen system to be installed in the parking facility, so that clients could simply select options for payment and access. The system would analyze inputs and then interact with the corresponding subsystems such as the control room, gate lift, security camera, and so on.

A UNO-2178A embedded automation computer was selected for this project because it has Energy Star certification, IP40 anti-dust ingress protection, and a wide operating temperature, providing high performance and high versatility with low power consumption. An ADAM-6060 Ethernet-based I/O module was used to enable remote monitoring and control of the gate lift. An FPM-7151T industrial monitor was also selected for its robust and true-flat touch screen design, including its IP66-rated front for protection against dust and water ingress. For further enhanced durability, the system also features an auto dimming function and supports high-brightness display (up to 1200 nits), and the high-brightness LCD plus optical bonding increases visibility while reducing reflections under direct/indirect sunlight.

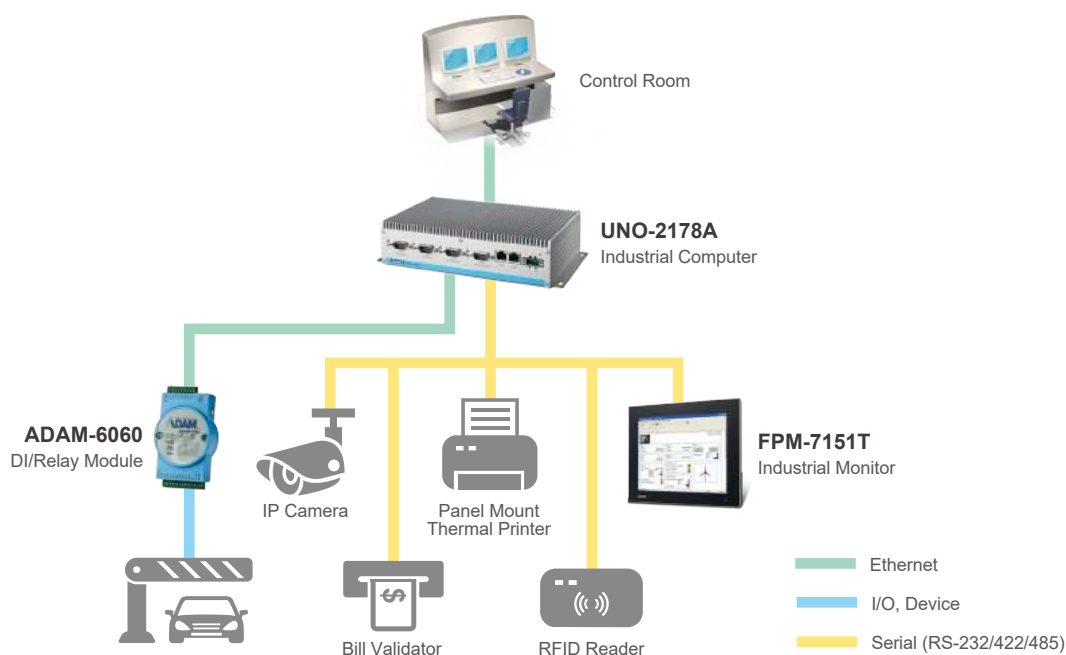

## Conclusion

The system has delivered reliable performance and has resulted in a significant reduction in total maintenance costs, and this has largely been attributed to the rugged design of Advantech's system. The ease of use and human hours saved have ensured that the system has been well-received. The overall savings and flexibility and functionality of the kiosk are the future of managing parking facilities.



INDUSTRY Agriculture

LOCATION China

Intelligent agriculture combines intelligent monitoring, IoT control, and product safety/traceability systems. It involves using network platform technology and cloud computing to realize the digitization of information, automation of production, and intelligent management of farming operations in order to establish a modern energy-saving agriculture system with a small carbon footprint, high yield, and green ecological orientation.

## Monitoring the Modern Agricultural Demonstration Zone in Real-time

### System Requirements

The Modern Agriculture Demonstration Zone in Qinghai Province, China, was founded in 2009. The zone was soon recognized as a National Agricultural Science and Technology Park by China's Ministry of Science and Technology in 2010, and it was then identified as a National Modern Agricultural Demonstration Zone by the Ministry of Agriculture in 2012.

The science and technology park covers an area of approximately 28 hectares. Its primary purpose is scientific research and innovation, but it also focuses on R&D on hybrids for highland rapeseed oil, potato

breeding and tissue cultures, and modern agricultural technology, as well as demonstrations of new species varieties, agriculture technologies and facilities, and farming culture. Related constructions include a high-tech R&D base for highland farming, a new rural development institute, and a scientific research and innovation base.

To establish an intelligent agriculture system, data acquisition needed to be in place to enable remote control of the bases, thus realizing the digitization of information and implementation of IoT technology in agriculture.

### Project Implementation



**ADAM-4068**  
8-ch Relay Output  
Module with Modbus



**ADAM-4117**  
Robust 8-ch Analog Input  
Module with Modbus



**WebAccess**  
Browser-based HMI/  
SCADA Software



**WebOP-2070T**  
[RTOS] 7" WVGA Operator  
Panel with WebAccess/  
HMI Software



## System Description

### Integrated Control System

The project for the modern agricultural science and technology park was implemented in a core region with 10 sub-bases. IoT technology was installed to enable the remote monitoring of the environment and soil moisture from a central control room. Data were transmitted to the control center in real time via an optical fiber network. In the control center, system software analyzes the data and automatically controls the hardware in the greenhouses to ensure that the greenhouse environment is optimal for crop growth. This approach is efficient for maximizing crop yield and quality while managing the ecology and ensuring the safety of personnel.

### Outdoor Weather Station Monitoring System

This system collects data on the temperature, humidity, sunlight intensity, soil moisture, wind direction, wind speed, rainfall, and other meteorological information. Through analysis, the system's automatic monitoring function enables users to visualize crop growth, moisture levels, seedling health, and insect and pest problems. Furthermore, it provides real-time, objective information for guiding agricultural production.

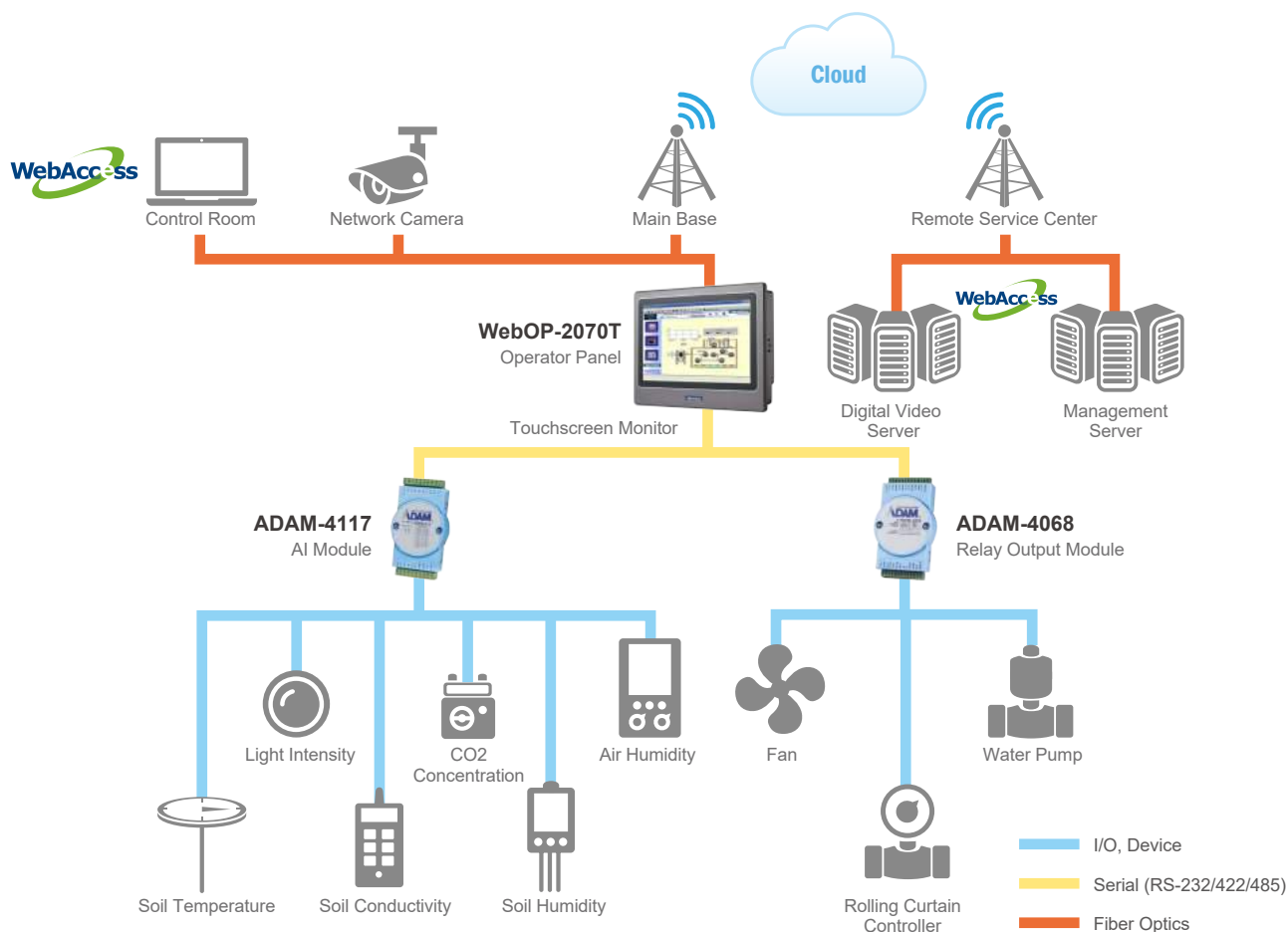

### Conclusion

Advantech provides total solutions for greenhouse environment monitoring applications, thus helping system integrators avoid communication problems during project implementation. Advantech's professional configuration software is convenient for customers to develop future applications aimed at agriculture informatization. The system enabled the customer to visualize greenhouse data on a large LCD screen in order to show Haidong National Science Park's latest scientific and technological achievements, demonstrate the agricultural bases, and monitor the park in real time. Meanwhile, the installed IoT devices enable remote control of the bases, thus realizing the IoT function of new technology in agriculture.



INDUSTRY Agriculture

LOCATION Taiwan

For people who live and work in big cities, growing their own fruits and vegetables is a dream that is often difficult to realize. But how about renting a greenhouse, and being able to remotely plant seeds, spray water and apply fertilizers through a web page, and then watching how your crops are growing via streaming video from an IP camera? A group of young Taiwanese entrepreneurs are making dreams come true by establishing greenhouse plots for rent with the latest Advantech technologies. These entrepreneurs have created a greenhouse automation and remote monitoring solution that allows users to control and monitor the environment via a virtual dashboard on a computer, smartphone, or other web-based device in real time.

## Remote Monitoring and Control on Web-Based Devices

### System Requirements

The customer divided their greenhouses into smaller compartments for rent, which meant that each section needed an independent set of agro-controller systems, including sensors (for temperature, humidity, soil pH, and more), IP cameras, automatic water sprays, fans, and so on. What they needed from Advantech included relay modules for remote control over actuators of equipment (e.g., water sprayers and fans), remote I/O modules for reading and transmitting sensor data, and HMISCADA software for remote monitoring and control and to produce user interfaces.

In the past, industrial automation control used special protocols such as Modbus for field communications. Now, however, with products like Advantech's ADAM-6200 series of I/O modules, which have a built-in Ethernet switch and support HTTPS and client devices and can communicate with I/O modules directly without the need for a data converters or routing from the SCADA system, system developers or service providers who are unfamiliar with traditional automation technologies will find it easier to configure or develop their applications in an IT-based and web-enabled environment.

### Project Implementation



**ADAM-6217**  
8-ch Isolated Analog Input  
Modbus TCP Module



**ADAM-6266**  
4-ch Relay Output  
Modbus TCP Module  
with 4-ch DI



**WebAccess**  
Browser-based HMI/  
SCADA Software

## System Description

About 40 Advantech ADAM-6266 modules were deployed for relay controls and nearly 20 ADAM-6217 modules were deployed for sensor data acquisition. Because these modules are multi-channel modules, each of them can be used to simultaneously monitor several compartments operated by different persons.

The ADAM-6200 has integrated Ethernet switches and can connect to each other in a daisy chain topology without the need for additional Ethernet switches. This topology is a particularly useful configuration because it can save on the expense of physical wires. To enable their clients to monitor the exact status of their gardens, the customer installed the latest version of WebAccess HMI/SCADA software, which incorporates Advantech's hardware monitoring and diagnosis firmware/software package WebAccess/RMM. Thus, they can remotely monitor the CPU temperature, fan speed, and other hardware parameters via a low-cost system management that allows for easy maintenance.

Since the ADAM-6200 series and WebAccess 8.0 support HTML5 and the RESTful webpage architecture, the customer can use the Advantech-designed Widget Library and Dashboard Editor to easily customize their desired cross-platform dashboard page, thus allowing them to display dynamic data on end user devices (e.g., PC, iPad, smartphone). ADAM-6200 series modules with WebAccess 8.0 were an extraordinary combination for the customer because of their easy installation and quick configuration, which saved a considerable amount of development and deployment time.

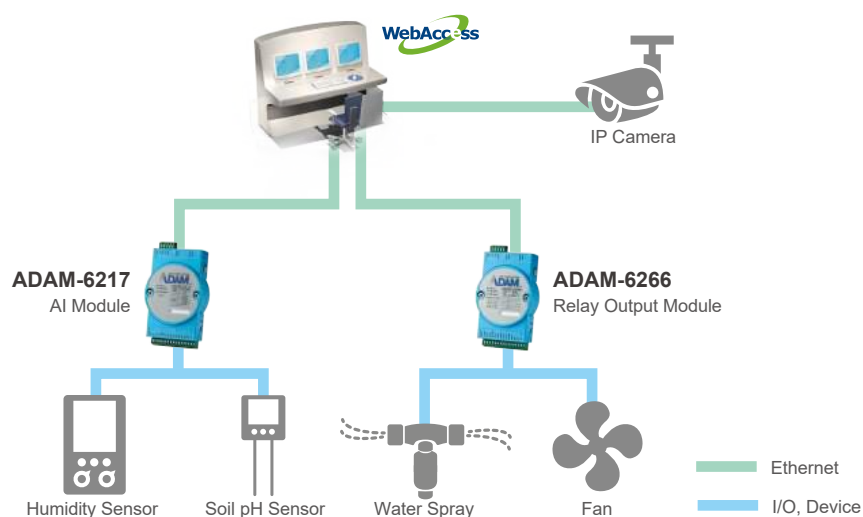

### Conclusion

Advantech's data acquisition solution is remarkable for its scalability, availability, and manageability, derived from its multiple and easy-to-use remote control and maintenance functions. Advantech was chosen as a solution provider in this case because of the company's experience with remote greenhouse monitoring solutions, including one for Taiwan's largest biggest orchid flower grower. As such, the company has a proven reputation in providing state-of-the-art greenhouse applications.



INDUSTRY Oil & Gas

LOCATION South China Sea

The real-time information system of this offshore oil well platform uses data acquisition technology and satellite-aided transmission to deliver data between the well site and central command. It allows on-site supervisors, base technicians, and experts to remain up-to-date on well site information without having to visit the site, while facilitating rapid and remote decision-making and command of operations. The features of this completely integrated service system ensure operational timeliness, stability, and simplicity by providing instant data delivery and analysis capabilities.

## On-Site Data Collection in Harsh Offshore Environments

### System Requirements

The predecessor of the offshore oil well platform was an offshore drilling platform, which used a real-time data acquisition system to collect information on the drilling well and rod. This information would then be compiled into drilling depth reports, which the management center would inspect to verify whether drilling was on schedule. When drilling was completed, the data acquisition system had to be upgraded so that it could acquire and upload oil well data (e.g., temperature, pressure, and flow) in real time.

### Project Implementation



**ADAM-6217**  
8-ch Isolated Analog Input  
Modbus TCP Module



**EKI-2525I**  
5-port Unmanaged  
Industrial Ethernet  
Switch w/ Wide Temp



**UNO-2174**  
Intel® Atom™ N450  
Automation Computers  
with 6 x USB, 8 x COM,  
2 x Mini PCIe



**WebAccess**  
Browser-based HMI/SCADA  
Software

## System Description

The customer required on-site data collection with network communication capability. The ADAM-6217 Ethernet I/O module and UNO-2174 embedded automation computer with WebAccess were selected because of their synergy in providing a complete system for data collection, processing, and uploading.

The ADAM-6217 has low power consumption and low heat dissipation, making it perfect for installation in closed environments. They also allow for a daisy chain topology, providing a simple and convenient means for connecting multiple devices while conserving space inside the control box and reducing installation costs. For these reasons, the ADAM-6217 was selected to connect to high-precision meters that also offered waterproofing and explosion protection.

Each drilling platform had four sealed ADAM-6217 units connected to a UNO-2174 computer via an EKI-2525I Ethernet switch. The UNO-2174 was installed in the oil well control room and is responsible for processing the collected data using WebAccess. After processing, the data are transmitted to a shore monitoring center via the International Maritime Satellite.

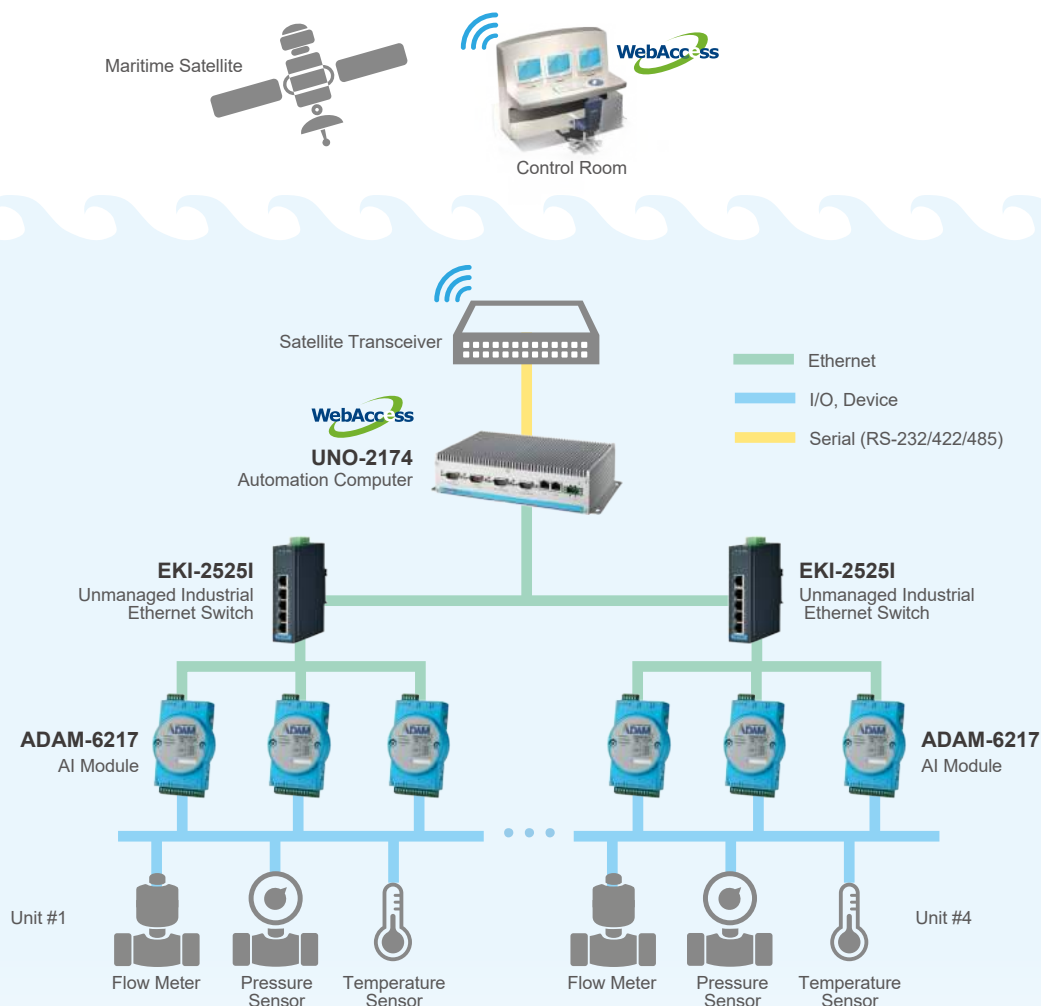

### Conclusion

In addition to providing both reliability and convenience, the system functions made the customer's current system structure more rigorous than the previous system, which comprised RS-485 data acquisition modules. Moreover, successfully upgrading to the new system was relatively inexpensive.



INDUSTRY Power

LOCATION China

To promote education in the field of electrical engineering, a Zhejiang University cooperated with a private enterprise to build an experimental platform that simulates high-voltage cable tunnel monitoring systems. The platform utilizes a combination of simulation and practice applications about cable tunnel monitoring, such as the monitoring of toxic gas concentrations, tunnel water levels, and manholes. By monitoring data in real time, the system can provide an early warning in the event of an emergency in order to improve the safety of tunnel staff and the stability of equipment.

## Stable and Reliable Equipment Operation Improves Overall Safety

### System Requirements

High-voltage cable tunnel environments expose tunnel staff to a certain degree of risk. Thus, it is necessary to protect their safety in addition to ensuring the long-term stability and reliability of power supply equipment. This emphasizes the need to accurately judge and quickly respond to changes in on-site conditions pertaining to the equipment and tunnel environment.

Given that cable tunnels are prone to high concentrations of toxic flammable gases and low levels of oxygen, the real-time monitoring of gas levels (e.g., carbon monoxide, methane, hydrogen sulfide, and oxygen) can prevent accidents and avoid fire hazards while providing security

for high-voltage cable operations.

Water level monitoring is also crucial to ensuring that tunnel drainage systems are operating normally and that there are no potential dangers. It can also prevent tunnels from becoming flooded, which would pose a security risk and potentially cause equipment shutdowns, resulting in unnecessary economic losses.

The monitoring of manholes is also critical to prevent unauthorized access to cable tunnels, and this security measure further ensures system reliability.

### Project Implementation



**ADAM-6217**  
8-ch Isolated Analog Input  
Modbus TCP Module



**ADAM-6250**  
15-ch Isolated Digital I/O  
Modbus TCP Module



**IPC-610**  
4U Rackmount Chassis  
with Visual Alarm  
Notification



**WebAccess**  
Browser-based HMI/  
SCADA Software

## System Description

Because of the potentially harmful risk factors in high-voltage cable tunnels, field work has to be minimized as much as possible. Thus, this customer's tunnels were often left unattended. To ensure stable, reliable, and safe operation, the customer required that the condition of high-voltage cables, power transmission equipment, and on-site environment be monitored in real time so that preventive measures could be taken in the event of an imminent emergency.

The monitoring system for the cable tunnels was a combination of software and hardware. This integrated system enables the acquisition, uploading, visualization, and storage of tunnel data and images (e.g., cable temperature, gas concentration, water level, and manhole status) via a single platform interface, thus facilitating supervision, management, early warning, and historical data traceability.

The platform utilized Advantech ADAM-6217 and ADAM-6250 Ethernet I/O modules to connect to smoke sensors, temperature sensors, pressure sensors, and other sensors for data acquisition. For the real-time transmission and storage of data and alarm information, WebAccess HMI/SCADA with 75 tags was adopted for secondary development so that the platform could be made more intuitive and complete.

This integrated monitoring system aggregates real-time data from cable temperature and tunnel environment monitoring subsystems. To ensure safety, the system now analyzes equipment data to predict potential cable failures, manage the fire warning and alarm status, and detect the gas concentration, water level, and other situations in the tunnels.

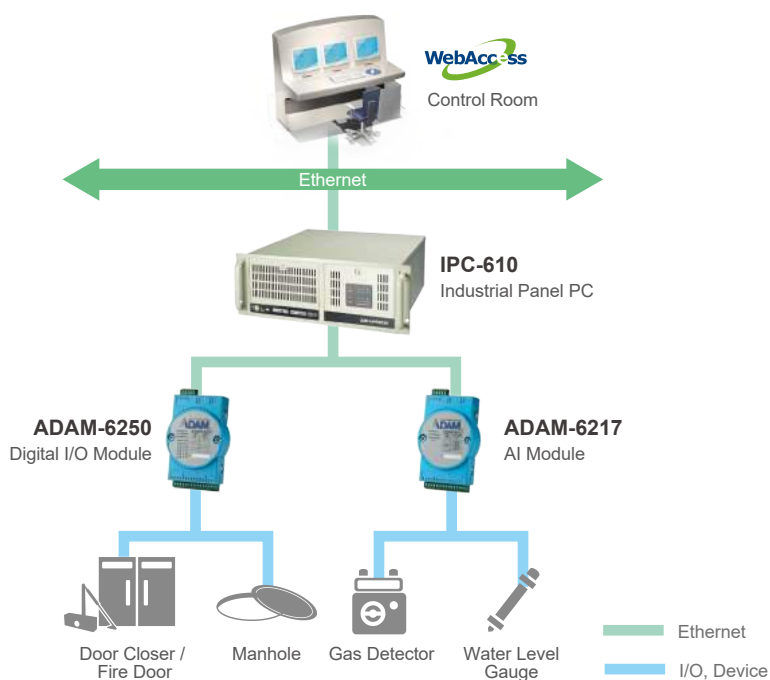

## Conclusion

The platform is easy to operate and comprehensively simulates actual field operations in the monitoring of tunnel environments. Furthermore, the stable and reliable equipment operation has improved overall system safety with a shortened system development time. Finally, maintaining system stability has enhanced security and reduced maintenance costs in the long run.



INDUSTRY Solar LOCATION Taiwan

Electricity generation capacity is one of the most important operational indicators of this large-scale PV grid-connected power plant. In addition to the wear and tear of inverters, transformers, cables, and other equipment, solar panels becoming dirty from dust, bird droppings, or other debris affect the capacity of electricity generation. In severe situations, buildup of dirt and debris can even induce the hot-spot effect. When the surface of a solar panel is covered in grime, the PV components cannot work properly, which lowers the equipment's power generation efficiency. Thus, the implementation of automated cleaning system is significant for the solar industry.

# Remote Automatic Data Transmission Achieves Efficient Human-Computer Interaction

## System Requirements

This customer's 1-MW PV power station mostly adopted a manual cleaning method to clean its solar panels. According to statistics, a cleaner can wash approximately 100 m<sup>2</sup> of solar panels per day; considering that this PV plant covers an area of approximately 6,600 m<sup>2</sup>, it would take approximately 66 days to clean the entire plant. At an estimated cost of 80 RMB per person per day, the annual cleaning cost would be approximately 190,000 RMB if cleaning was performed on a monthly basis.

Moreover, differences in cleaning quality between staff

make the cleaning process inefficient and difficult to control. Cleaning can also cause wear on glass surfaces, affecting the light transmission ability and lifespan of PV components. Thus, determining how to solve the problem of dust and debris degrading the performance of the PV panels in addition to determining how to implement an automated cleaning system to reduce operational and maintenance costs were issues of common concern among the power station owners as well as engineering, procurement, and construction contractors.

## Project Implementation



**ADAM-4117**  
Robust 8-ch Analog Input Module with Modbus



**ADAM-4150**  
Robust 15-ch Digital I/O Module with Modbus



**EKI-1334**  
Industrial Ethernet/Serial Router



**UNO-2174A**  
Intel® Atom™ N450  
Automation Computers with  
6 x USB, 8 x COM, 2 x Mini PCIe



**WebAccess**  
Browser-based HMI/  
SCADA Software



## System Description

Using IoT technology and an industrial-grade computer, the operations/maintenance center of the PV power plant employs an on-site intelligent robot for the cleaning and fault diagnosis of PV components when the power generation efficiency of panels diminishes.

Collection of temperature and meteorological data information and control of the cleaning robot are achieved using the ADAM-4117 remote I/O module. The module transmits data via RS-485 network to the UNO-2174A embedded industrial computer, which also has built-in monitoring software. Data communication with the operations/maintenance center is realized using the EKI-1334 Ethernet/serial router, which operates via 3G. By combining these data with the component power generation efficiency curve, the operations/maintenance center can determine when cleaning should be performed.

The intelligent robot can clear 99% of dust and debris from PV components. Furthermore, it can operate at night, thus substantially improving the efficiency compared to manual cleaning.

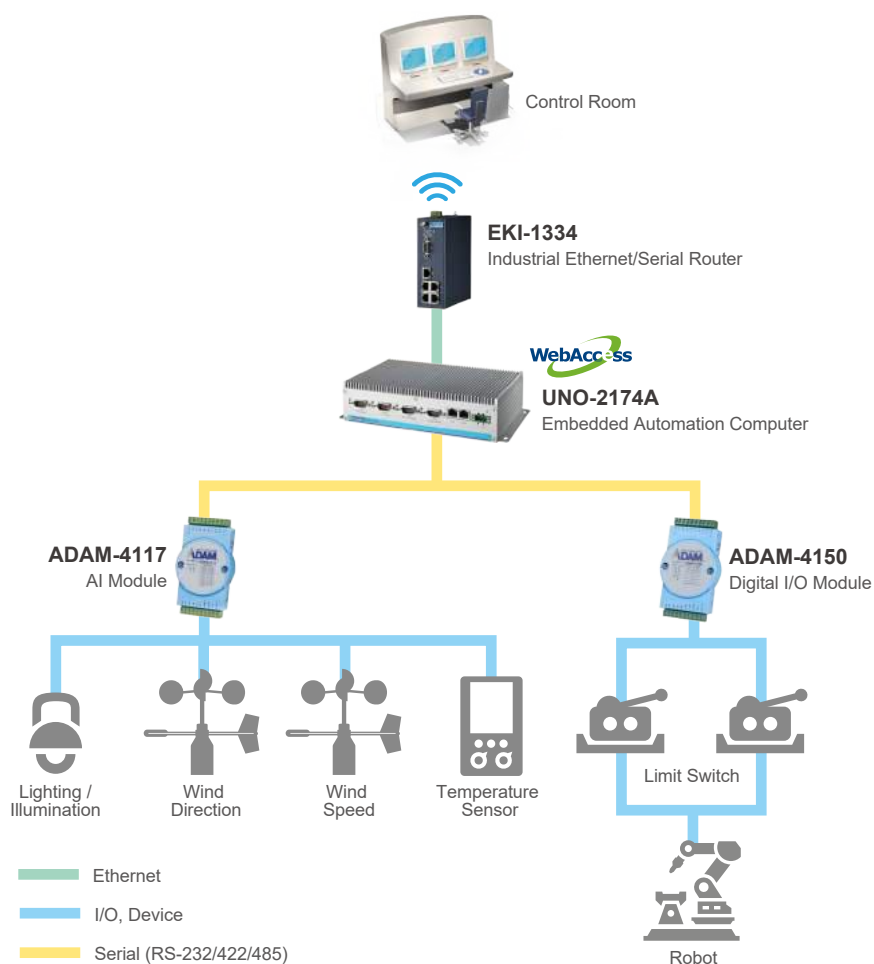

## Conclusion

The customer's dust and weather monitoring system was integrated into a single machine to maximize resource use efficiency. Through Advantech's extensive experience, we were able to provide professional system integration, communication, and remote automatic data transmission via Internet and cellular interconnection to achieve smooth and efficient human-computer interaction.



INDUSTRY Wind

LOCATION China

Wind energy is a ubiquitous and inexhaustible clean renewable energy source that does not produce greenhouse gases during power generation. Large wind power plants comprise hundreds of turbines and tend to be located in sparsely populated, natural environments that are prone to dust and gale-force winds. Thus, ensuring the safe and reliable operation of wind power plants is critical. The ability to collect and upload meteorological data in real time at wind farms has become integral to wind farm management systems.

## Real-Time Monitoring Solution Simplifies Field Operations

### System Requirements

At a wind power generation plant in the grasslands of Inner Mongolia, temperatures reach as low as  $-40^{\circ}\text{C}$  during winter and exhibit a wide diurnal pattern. At this customer's plant, meteorological instrument shelters are situated 200 m from the wind turbines. Dispatching staff to each shelter to record weather information is inefficient and costly, resulting in a lack of immediacy in applying the data.

Any PC with a fan could not be used as a host platform

in this environment because fan failure—and eventually system failure—would occur. Thus, the plant required a fanless monitoring system that would also be compatible with the currently used wind turbine vibration monitoring system so that the control center could remotely access weather and turbine vibration data without requiring a major upgrade. For this, an industrial-grade wireless Ethernet network was constructed to save on wiring costs and the installation time.

### Project Implementation



#### ADAM-4117

Robust 8-ch Analog Input Module with Modbus



#### ADAM-4118

Robust 8-ch Thermocouple Input Module with Modbus



#### EKI-1521

1-port RS-232/422/485 Serial Device Server



#### EKI-6332GN

Wireless AP/Client



#### UNO-3083G

Intel Core i7/Celeron 800 series Automation Computers with 3/5 PCI(e) expansion slots, 2 Mini PCIe slots and 2 CFast sockets



#### WebAccess

Browser-based HMI/SCADA Software

## System Description

At the device end, Advantech's robust ADAM-4117 and ADAM-4118 remote I/O modules were employed for the real-time acquisition of various meteorological parameters such as temperature, humidity, wind speed, and wind direction. For communication, the ADAM modules were connected using an EKI-1521 serial device server, enabling the seamless integration of on-site sensors via an Ethernet connection.

Advantech's UNO-3083G embedded industrial computer, which comes with embedded WebAccess configuration software, was used to visualize and analyze the long-term operating condition of the wind turbines (for periods up to 20 years). In addition, SCADA software provides real-time data monitoring, fault alarms, and custom reports while supporting PCs, tablet PCs, and other mobile devices, thus allowing decision-makers to obtain field information.

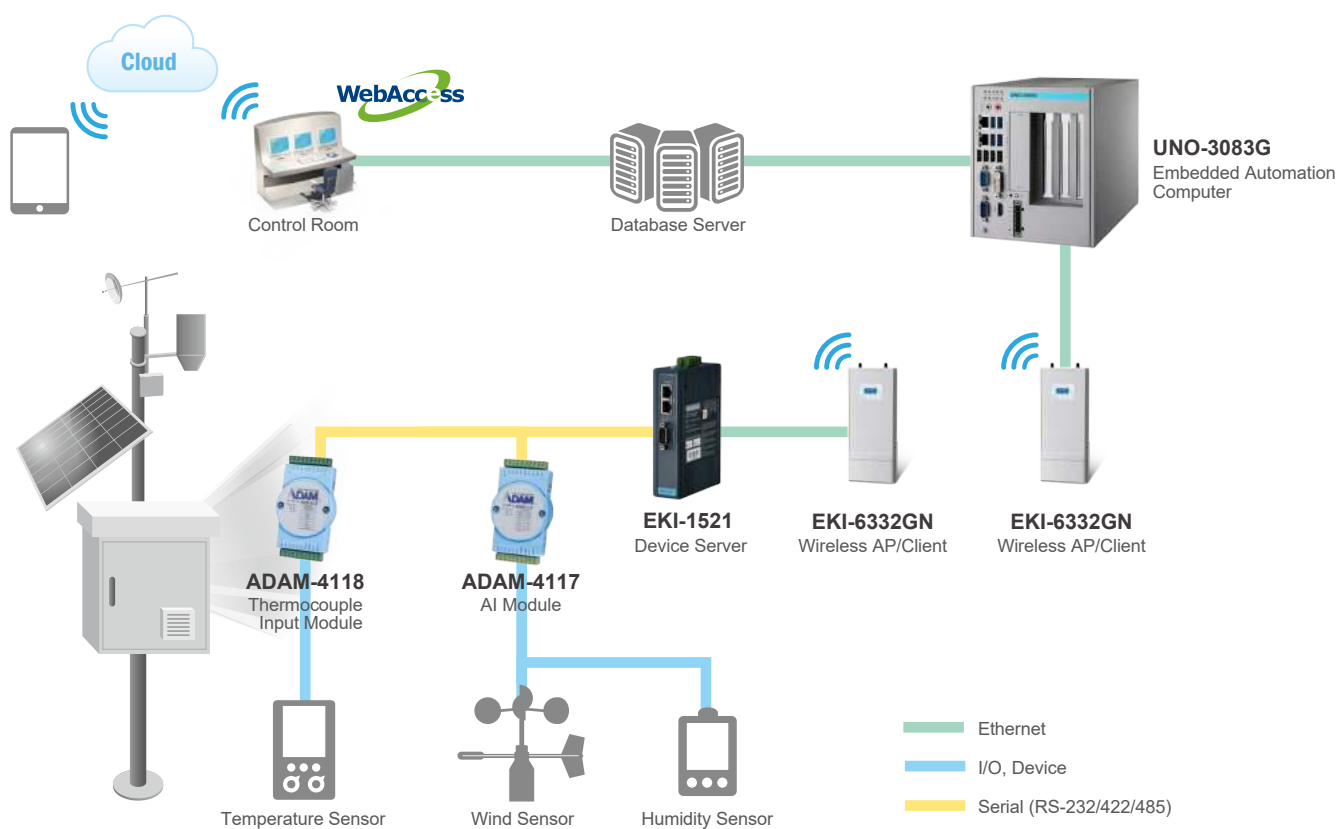

## Conclusion

Advantech's real-time monitoring solution for this wind farm provided complete functionality that maximized the plant's operational efficiency. The intelligent gateway performed suitably in obtaining on-site data, the wireless communication configuration meant that complex wiring difficulties were avoided, and the cloud server enabled big data processing and fault feature extraction. The wind power monitoring solution has helped the plant rapidly implement the project and save time by not having to perform compatibility testing and debugging.

Vertrieb durch



**AMC – Analytik & Messtechnik GmbH Chemnitz**

Heinrich-Lorenz-Str. 55

Tel.: +49/371/38388-0

09120 Chemnitz

Fax: +49/371/38388-99

E-Mail: [info@amc-systeme.de](mailto:info@amc-systeme.de)

Web: [www.amc-systeme.de](http://www.amc-systeme.de)

**ADVANTECH**

*Enabling an Intelligent Planet*



**ADVANTECH** iAutomation

**Premier Partner**

Please verify specifications before ordering. This guide is intended for reference purposes only.

All product specifications are subject to change without notice.

No part of this publication may be reproduced in any form or by any means, electronic, photocopying, recording or otherwise, without prior written permission of the publisher.

All brand and product names are trademarks or registered trademarks of their respective companies.

© Advantech Co., Ltd. 2018